

Lossless Bit Depth Scalable Coding for Floating Point Images

Chew Yin Ping¹Takuya Shibata¹Masahiro Iwahashi¹Hitoshi Kiya²

¹Nagaoka University of Technology
Nagaoka, Niigata, Japan

²Tokyo Metropolitan University
Hino, Tokyo, Japan

Abstract— This paper presents a two-layer lossless bit depth scalable coding for RGB color components of high dynamic range (HDR) images. We introduce a two-stage tone mapping, which is composed of a reversible logarithmic mapping and its compensation, to produce a tone mapped LDR image in the base layer. Adding bit stream in the enhancement layer, which carries difference between the original HDR image and its approximation, the original HDR image is reproduced without any loss. The reversible logarithmic mapping is utilized to reduce bit depth of the enhancement layer for lossless coding. We have confirmed that the proposed method significantly reduces bit depth and bit rate of HDR color images in the enhancement layer.

Keywords— scalable, reversible, coding, tone mapping

1. INTRODUCTION

High dynamic range (HDR) images have been around for many years [1]. Recently, they have been gaining popularity among users thanks to development of advanced HDR cameras. They allow users to capture images in much larger dynamic range of pixel values. Since most of currently standard devices can't display full dynamic range of the HDR images, tone mapping operators are applied to produce low dynamic range (LDR) images [2-3]. Therefore coexistence of HDR image and LDR image should be considered in research development of advanced systems.

HDR images require large memory space for storage and huge bit rates (band width) for transmission. Therefore, it makes data compression technologies essential for usage. So far, various approaches based on international standard compression algorithms such as JPEG or MPEG have been reported. Those can be categorized into 'single' layer coding and 'double' layer coding.

As an example of the single layer coding, R. Xu applied a logarithm function to an HDR image to reduce its dynamic range [4]. A resulting LDR image is coded with JPEG encoder to compress its data volume. However, the original HDR image can't be regained with acceptable quality.

On the other hand, the double layer coding, also referred to the bit depth scalable coding, provides good quality of both of LDR image and HDR image reconstructed in decoder side. It

provides two kinds of bit streams. One in the base layer carries information for decoding the LDR image which was tone mapped from the original HDR image. The other in the enhancement layer carries auxiliary information to reproduce approximated HDR image.

So far, numerous reports have been published on the double layer coding [5-9]. One of the basic approaches can be found in [5]. Some of them focused on inverse tone mapping to produce good approximation of the HDR image in decoding side [6-7]. Improvement on the residual information in the enhancement layer can be found in [8], and improvement on the forward tone mapping was reported in [9]. However the original HDR image can't be decoded without any loss in those existing methods.

Recently, we have proposed a bit depth scalable coding which enables reconstructing the original HDR image without any loss [10,11]. It also provides a bit stream for LDR image which can be decoded with an international standard decoder. In the previous report, we have confirmed its effectiveness on reducing bit depth and bit rate of the enhancement layer. However, its investigation was limited to mono tone images.

In this report, we will extend our previous investigation to color images, and modify the inverse tone mapping and the inverse compensation procedures. In our experiments, we confirm that our method is able to reduce bit depth and bit rate of the enhancement layer for color input images.

2. EXISTING METHOD

A. Floating Point Data Format

Floating point data format is able to hold huge amount of information, and therefore it is suitable for representing high dynamic range of pixel values. In this report, we consider the case where a pixel value $x_{H,C}$ of each color component $C \in \{R,G,B\}$ of the original HDR image is represented as

$$x_{H,C} = (1 + x_{M,C} \cdot 2^{-D_M}) \cdot 2^{x_{E,C} - E_0} \quad (1)$$

where

$$x_{M,C} \in [0, 2^{D_M} - 1] \quad \text{and} \quad x_{E,C} \in [0, 2^{D_E} - 1].$$

Integers $x_{M,C}$ and $x_{E,C}$ are given as D_M bit mantissa and D_E bit exponent, respectively. For example, the OpenEXR format has the bit depth of $D_M=10$ and $D_E=5$. A constant E_0 is set to 15 for $1 \leq x_{E,C} \leq 30$, e.g. The OpenEXR supports 'sign' bit to represent negative pixel values, however it is not a part of our consideration in this report without loss of generality.

B. Tone Mapping from HDR to LDR

Fig.1 illustrates a diagram of the existing method. In order to decode the original HDR image without any loss, a floating point HDR pixel value $x_{H,C}$ is mapped into an integer as

$$x_{I,C} = x_{H,C} \cdot 2^{D_M+E_0-E_1}. \quad (2)$$

From (1) and (2), it becomes

$$\begin{aligned} x_{I,C} &= f_{Int}(x_{M,C}, x_{E,C}) \\ &= (x_{M,C} + 2^{D_M}) \cdot 2^{x_{E,C}-E_1}. \end{aligned} \quad (3)$$

In (2) and (3), a constant E_1 is set to the minimum of $x_{E,C}$ among pixels of the original HDR image, so that $x_{I,C}$ becomes an integer. The inverse of this mapping is

$$\begin{aligned} (x_{M,C}, x_{E,C}) &= f_{Int}^{-1}(x_{I,C}) \\ \text{for} \quad & \begin{cases} x_{E,C} = \lfloor \log_2(x_{I,C}) \rfloor - D_M + E_1 \\ x_{M,C} = x_{I,C} \cdot 2^{-x_{E,C}+E_1} - 2^{D_M} \end{cases} \end{aligned} \quad (4)$$

where $\lfloor x \rfloor$ denotes flooring of x to an integer. This inverse mapping reconstructs the original $x_{E,C}$ and $x_{M,C}$ from the integer HDR image $x_{I,C}$ without any loss, i.e. 'reversible'. Note that conversion from $x_{I,C}$ to $x_{H,C}$ is given as

$$x_{H,C} = x_{I,C} \cdot 2^{-D_M-E_0+E_1} \quad (5)$$

and it is also reversible.

In the base layer, a tone mapping function is applied to the HDR image $x_{H,C}$ to produce the LDR image $x_{L,C}$ as

$$x_{L,C} = f_{Tmp}(x_{H,C}) = \frac{x_{L,Y}}{x_{H,Y}^s} \cdot x_{H,C}^s \quad (6)$$

where

$$\begin{aligned} x_{L,Y} &= f_{Hill}(x_{H,Y}) \\ &= \frac{255 \cdot \left(\frac{x_{H,Y}}{\bar{x}_{H,Y}} \right)^a}{\left(\frac{x_{H,Y}}{\bar{x}_{H,Y}} \right)^a + b^a} = \frac{255}{\left(\frac{b \cdot \bar{x}_{H,Y}}{x_{H,Y}} \right)^a + 1} \end{aligned} \quad (7)$$

and the luminance of HDR $x_{H,Y}$ is generated from color components of HDR image as

$$\begin{aligned} x_{H,Y} &= f_{Lum}(x_{H,C}) \\ &= 0.27x_{H,R} + 0.67x_{H,G} + 0.06x_{H,B}. \end{aligned} \quad (8)$$

In (7), the geometric mean is calculated as

$$\bar{x}_{H,Y} = \exp(E[\log_e(x_{H,Y})]) \quad (9)$$

where $E[\]$ denotes the arithmetic mean over pixels in the image. This tone mapping has three parameters a , b and s . All of them are set to 1 in this report.

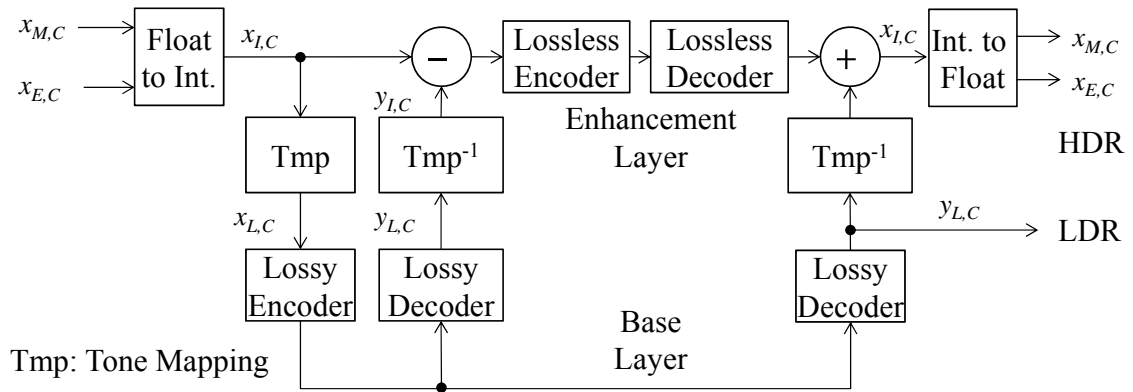

Fig.1 Existing Method

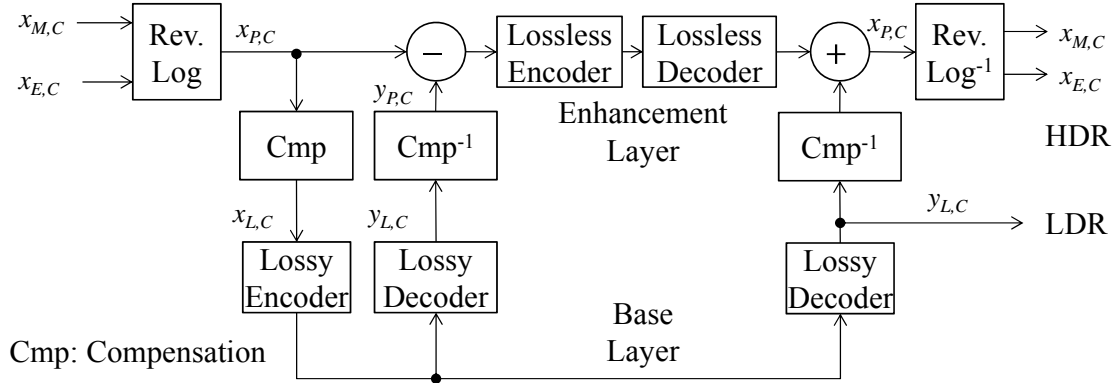

Fig.2 Proposed Method

C. Encoding and Decoding

In the existing method, the LDR image $x_{L,C}$ is rounded to integer and its data volume is compressed with a standard lossy encoder to produce a bit stream in the base layer. It is decoded to reconstruct the LDR image $y_{L,C}$, which contains quantization error, and displayed with a standard device. In the enhancement layer, (2) and inverse of (6) are applied to $y_{L,C}$ to produce an approximation of integer HDR image $y_{I,C}$ as

$$y_{I,C} = f_{Tmp}^{-1}(y_{L,C}) \cdot 2^{D_M + E_0 - E_1}. \quad (10)$$

Implementation of this inverse procedure is described in 3. A lossless international standard encoder is applied to the difference $y_{I,C} - x_{L,C}$ to produce a bit stream in the enhancement layer. Utilizing histogram sparseness of $x_{I,C}$, the bit depth and the bit rate in the enhancement layer is significantly reduced by the proposed method as experimentally confirmed in 4.

3. PROPOSED METHOD

A. Reversible Logarithmic Mapping (Rev.Log)

Fig.2 illustrates the proposed method. To ensure that the HDR is decoded without any loss, and to reduce bit depth of the enhancement layer, we apply a reversible logarithmic mapping 'Rev.Log'

$$\begin{aligned} x_{P,C} &= f_{Log}(x_{M,C}, x_{E,C}) \\ &= x_{M,C} + x_{E,C} \cdot 2^{D_M}. \end{aligned} \quad (11)$$

This procedure itself can be found in a previous report such as [12]. Its inverse is

$$\begin{aligned} (x_{M,C}, x_{E,C}) &= f_{Log}^{-1}(x_{P,C}) \\ \text{for} \quad & \\ \begin{cases} x_{E,C} &= \lfloor x_{P,C} \cdot 2^{-D_M} \rfloor \\ x_{M,C} &= x_{P,C} - x_{E,C} \cdot 2^{D_M} \end{cases} \end{aligned} \quad (12)$$

and this is reversible, i.e. $x_{M,C}$ and $x_{E,C}$ can be reconstructed from $x_{P,C}$ without any loss. Due to this rearrangement, the bit depth of $x_{P,C}$ is considerably reduced compared to $x_{L,C}$. We have already confirmed its effectiveness on lossless coding in [10,11]. However its experimental results were limited to mono tone images. In this report, we consider some required modifications on the tone mapping so that it can be applied to RGB color components.

B. Compensation (Cmp) to Produce LDR Image

Since the integer $x_{P,C}$ is not the LDR image, it should be compensated to be the LDR image $x_{L,C}$ in the proposed method. The compensation 'Cmp' is defined as

$$x_{L,C} = f_{Cmp}(x_{P,C}). \quad (13)$$

It is composed of (12), (3), (5), (6), i.e.

$$f_{Cmp}(x_{P,C}) = f_{Tmp}\left(f_{Int}\left(f_{Log}^{-1}(x_{P,C})\right) \cdot 2^{-D_M + E_1 - E_0}\right). \quad (14)$$

This compensation produces the LDR image exactly same as the image produced by the existing method. Therefore, there is no significant difference between the existing method and the proposed method in the base layer.

C. Inverse Tone Mapping

One of the most important parts of this report is how to implement the inverse of the tone mapping in (6), and that of the compensation in (14). According to (6), its inverse is defined as

$$x_{H,C} = f_{Tmp}^{-1}(x_{L,C}) = \frac{x_{H,Y}}{x_{L,Y}^{1/s}} \cdot x_{L,C}^{1/s} \quad (15)$$

Some difference exists in the way to generate the ratio of luminance $x_{H,Y}$ and $x_{L,Y}$. The simplest approach is

$$f_{Tmp}^{-1}(x_{L,C}) = \frac{f_{Lum}(x_{H,C})}{(f_{Hill}(f_{Lum}(x_{H,C})))^{1/s}} \cdot x_{L,C}^{1/s} \quad (16)$$

which is just a result of substituting (7), (8) into (15). There is no problem in a lossy system such as [5] since the ratio of luminance is carried in the enhancement layer. However, it can't be implemented in our system, since the HDR image $x_{H,C}$ should be reconstructed from only the LDR image $x_{L,C}$. Therefore, instead of (16), we use

$$f_{Tmp}^{-1}(x_{L,C}) = \frac{f_{Hill}^{-1}(f_{Lum}(x_{L,C}))}{(f_{Lum}(x_{L,C}))^{1/s}} \cdot x_{L,C}^{1/s} \quad (17)$$

as the inverse of the tone mapping in (6).

D. Inverse Compensation

Similarly, we construct the inverse of the compensation in (14) as

$$f_{Cmp}^{-1}(x_{L,C}) = f_{Log} \left(f_{Ini}^{-1} \left(f_{Tmp}^{-1}(x_{L,C}) \cdot 2^{D_M - E_1 + E_0} \right) \right). \quad (18)$$

Substituting (17), (2), (4) and (11) into (18),

$$y_{P,C} = f_{Cmp}^{-1}(y_{L,C}) \quad (19)$$

is reconstruct as indicated with bold lines in Fig.4. Finally the difference $y_{P,C} - x_{P,C}$ is encoded to produce a bit stream in the enhancement layer. Since the 'Rev.Log' reduces the bit depth of $x_{P,C}$ as well as $y_{P,C}$, the bit rate of the enhancement layer is effectively reduced as confirmed in the next section.

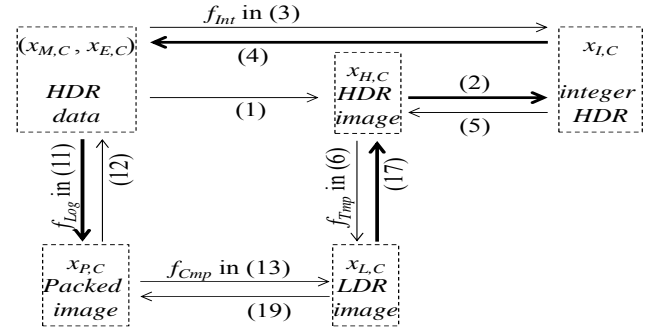

Fig.4 Relations among the mapping functions

4. EXPERIMENTAL RESULTS

Fig. 5 shows an example of LDR images, which is tone mapped from the original color HDR image 'Cannon' given in OpenEXR format. Fig.6 summarizes rate-distortion curves in the base layer. JPEG 2000 lossy encoder based on five octave 9/7 discrete wavelet transform with the optimum bit allocation is applied as the lossy encoder. It indicates that there is no difference between the existing method and the proposed method in lossy coding of the LDR image in the base layer.



Fig. 5 Tone mapped LDR image 'Cannon'.

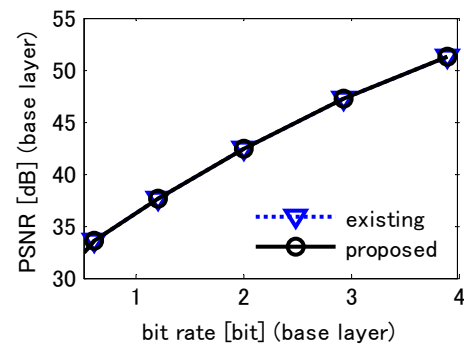

Fig.6 Rate distortion curves of the base layer (color).

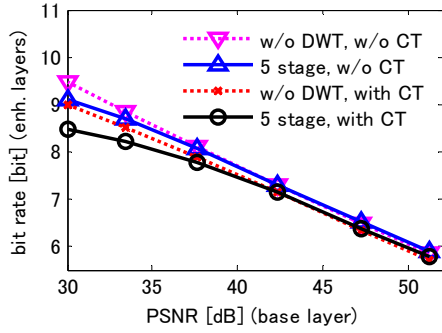

Fig.7 Bit rate of the enhancement layer (color).

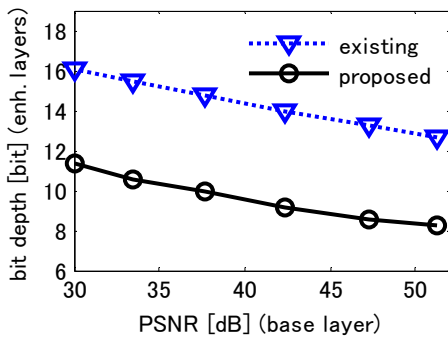

Fig.8 Bit depth of the enhancement layer (color).

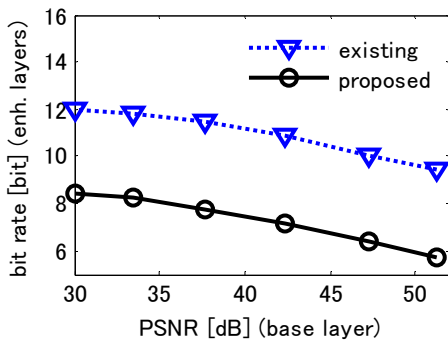

Fig.9 Bit rate of the enhancement layer (color).

Fig.7 indicates bit rate of the difference $y_{P,C} - x_{P,C}$ in the enhancement layer versus PSNR of the LDR image in the base layer. Parameters of the lossless coding in the enhancement layer were varied. It was found that the lossless coding with five stage integer 5/3 DWT (5 stage) and the reversible color transform (with CT) is the best. These parameters were used in the experiments below.

Fig.8 indicates comparison results in terms of bit depth of the difference $y_{P,C} - x_{P,C}$ in the enhancement layer. Defining the bit depth as $\log_2(\text{Max}-\text{Min}+1)$, reduction in bit depth of around 4 [bpp] for average of R , G and B color components was observed at any choice of quality of the LDR image.

Fig.9 indicates bit rate in the enhancement layer. It similarly indicates superiority of the proposed method to the existing method in lossless coding of the HDR image.

Fig.10 and Fig.11 indicate bit depth and bit rate of the enhancement layer for the luminance (black and white) image. These results indicate that the proposed method is effective for two layer lossless coding of HDR color images, as well as black and white images.

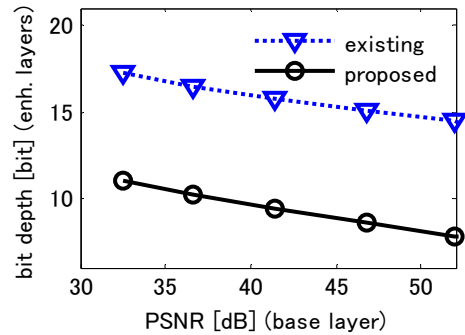

Fig.10 Bit depth of the enhancement layer (Luminance).

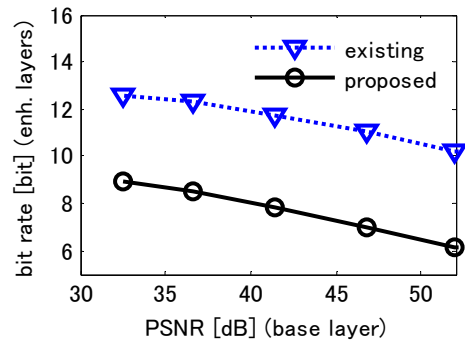

Fig.11 Bit rate of the enhancement layer (Luminance).

Fig.12 indicates another example of the image 'Mt.Tam West'. Its RGB color components composed of 704×1184 pixels were processed. Fig 13 indicates rate distortion curves of lossy coding of the LDR image. Similarly to Fig.6, no significant difference was observed in the base layer.

Fig.14 illustrates bit depth of the enhancement layer at different PSNR of the LDR image. It indicates that the integer HDR image $x_{H,C}$ has approximately 26 bit depth. On the contrary, bit depth of the packed image $x_{P,C}$ is less than 14 bit. It also confirms that introduction of the Rev.Log contributes bit depth reduction by approximately 12 bit for this image.

Fig.15 indicates bit rate of the enhancement layer. Superiority of the proposed method was observed to be more than 7 bit for this color image.



Fig. 12 Tone mapped LDR image 'Mt.TamWest'.

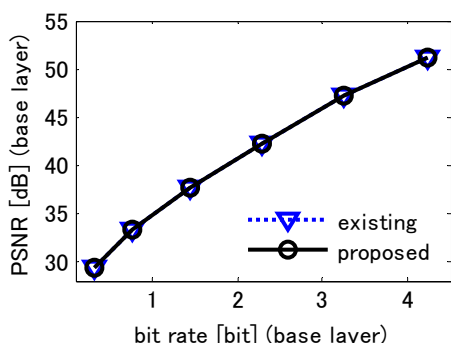

Fig.13 Rate distortion curves of the base layer (color).

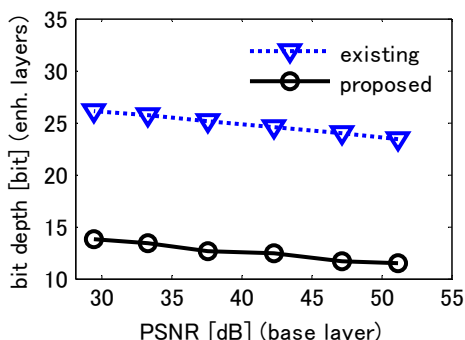

Fig.14 Bit depth of the enhancement layer (color).

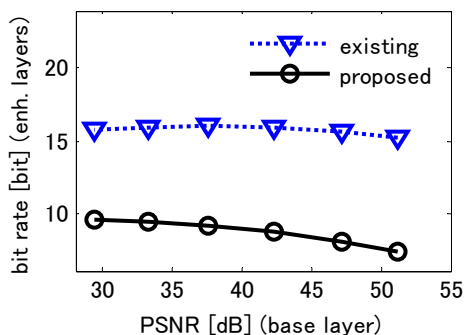

Fig.15 Bit rate of the enhancement layer (color).

5. CONCLUSION

A lossless bit depth scalable coding was proposed introducing reversible logarithmic (Rev.Log) mapping and its compensation. It was confirmed that the proposed method significantly reduces bit depth and bit rate of the enhancement layer due to histogram packing by the 'Rev.Log'.

For our future work, we will focus on improving approximation of HDR image for further reduction of bit depth of the enhancement layer.

REFERENCES

- [1] E. Reinhard, G. Ward, S. Pattanaik, P. Debevec, W. Heidrich, K. Myszkowski, "High Dynamic Range Imaging – Acquisition, Display and Image based Lighting," Morgan Kaufmann, 2010.
- [2] E. Reinhard, M. Stark, P. Shirley, J. Ferwerda, "Photographic Tone Reproduction for Digital Images," ACM Trans on Graphics. 21, 3, 267-276, 2002
- [3] F. Durand, and J. Dorsey, "Fast bilateral filtering for the display of high-dynamic-range images," ACM Transactions on Graphics (Proc. SIGGRAPH), vol. 21, no. 3, pp.257–266, 2002.
- [4] R. Xu, S. N. Pattanaik, C. E. Hughes, "High-Dynamic-Range Still Image Encoding in JPEG2000," IEEE Computer Graphics and Applications vol.25, no.6, pp.57-64, 2005.
- [5] G. Ward, M. Simmons, "JPEG-HDR: A Backwards-Compatible," High Dynamic Range Extension to JPEG, SIGGRAPH '05 Courses, ACM Article No.2 2005.
- [6] M. Okuda, N. Adami, "Two-Layer Coding Algorithm for High Dynamic Range Images based on Luminance Compensation," Journal of Visual Communication and Image Representation, vol.18, no.5, pp.337-386, 2007.
- [7] R. Mantiuk, A. Efremov, K. Myszkowski, H. P. Seidel, "Backward Compatible High Dynamic Range MPEG Video Compression", ACM SIGGRAPH 2006.
- [8] Ishtiaq Rasool Khan, "Two Layer Scheme for Encoding of High Dynamic Range Images," IEEE International Conference on Acoustics, Speech and Signal Processing (ICASSP), pp.1169-1172, 2008.
- [9] T. Jinno, M. Okuda, N. Adami, "New Local Tone Mapping and Two-Layer Coding for HDR Images," IEEE International Conference on Acoustics, Speech and Signal Processing (ICASSP), pp.765-768, March 2012.
- [10] M. Iwahashi, H. Kiya, "Two Layered Lossless Coding of High Dynamic Range Images," ITE Technical Report, vol.36, no.21, pp.17-20, IST2012-33, June, 2012.
- [11] M. Iwahashi, H. Kiya, "Efficient Lossless Bit Depth Scalable Coding for HDR Images," APSIPA OS.49-IVM.17, Dec. 2012.
- [12] James F. Blinn, "Floating-Point Tricks," IEEE Computer Graphics and Applications, pp.81-84, August 1997.